

Surname	Centre Number	Candidate Number
Other Names		0



GCSE – NEW

C300U20-1



S17-C300U20-1



MATHEMATICS – Component 2
Calculator-Allowed Mathematics
FOUNDATION TIER

THURSDAY, 8 JUNE 2017

– MORNING

2 hours 15 minutes

For Examiner's use only		
Question	Maximum Mark	Mark Awarded
1.	7	
2.	2	
3.	4	
4.	2	
5.	4	
6.	2	
7.	5	
8.	2	
9.	4	
10.	6	
11.	5	
12.	3	
13.	3	
14.	3	
15.	4	
16.	2	
17.	3	
18.	3	
19.	4	
20.	4	
21.	6	
22.	5	
23.	4	
24.	3	
25.	3	
26.	1	
27.	4	
28.	3	
29.	5	
30.	2	
31.	3	
32.	5	
33.	4	
Total	120	

ADDITIONAL MATERIALS

A calculator will be required for this examination.

A ruler, protractor and a pair of compasses may be required.

INSTRUCTIONS TO CANDIDATES

Use black ink or black ball-point pen.

You may use a pencil for graphs and diagrams only.

Write your name, centre number and candidate number in the spaces at the top of this page.

Answer **all** the questions in the spaces provided.

If you run out of space, use the continuation page at the back of the booklet, taking care to number the question(s) correctly.

Take π as 3.14 or use the π button on your calculator.

INFORMATION FOR CANDIDATES

You should give details of your method of solution when appropriate.

Unless stated, diagrams are not drawn to scale.

Scale drawing solutions will not be acceptable where you are asked to calculate.

The number of marks is given in brackets at the end of each question or part-question.

You are reminded of the need for good English and orderly, clear presentation in your answers.

Formula list*Area and volume formulae*

Where r is the radius of the sphere or cone, l is the slant height of a cone and h is the perpendicular height of a cone:

$$\text{Curved surface area of a cone} = \pi r l$$

$$\text{Surface area of a sphere} = 4\pi r^2$$

$$\text{Volume of a sphere} = \frac{4}{3}\pi r^3$$

$$\text{Volume of a cone} = \frac{1}{3}\pi r^2 h$$

Kinematics formulae

Where a is constant acceleration, u is initial velocity, v is final velocity, s is displacement from the position when $t = 0$ and t is time taken:

$$v = u + at$$

$$s = ut + \frac{1}{2}at^2$$

$$v^2 = u^2 + 2as$$

1. Mary and Philip are shopping. They see these labels in a bakery.

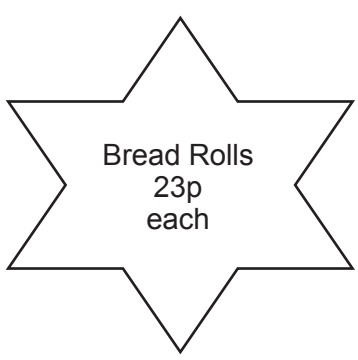

(a) Complete Mary's bill below.

[3]

Mary's bill	
10 bread rolls	£
2 birthday cakes	£
12 cupcakes	£
Total	£

.....

(b) Philip's bill at the bakery comes to £37. The bakery offers a £5 discount when a customer spends £40 or more. Philip decides to buy another pack of cupcakes.

(i) Explain why Philip decided to buy another pack of cupcakes.

[1]

.....

(ii) Work out how much Philip pays for his shopping.

[1]

.....

(c) The bakery also has a "4 for the price of 3" offer on birthday cakes. What would be the cost of 8 birthday cakes?

[2]

.....

2. (a) Kate was asked to compare the following fractions.

$$\frac{3}{5}$$

$$\frac{3}{4}$$

$$\frac{2}{3}$$

Kate tried to write them all using a common denominator of 20.

Explain what is wrong with her method.

[1]

.....

.....

.....

- (b) What is the lowest common denominator that should be used to compare these fractions? [1]

$$\frac{2}{5}$$

$$\frac{3}{8}$$

$$\frac{9}{20}$$

.....

.....

3. (a) Draw a diagram of the shape that is described below.

- The shape has 4 straight sides.
- The opposite sides are equal in length.
- The opposite sides are parallel to each other.
- There are no right angles.

[1]

(b) The diagram shows two triangles and a trapezium.

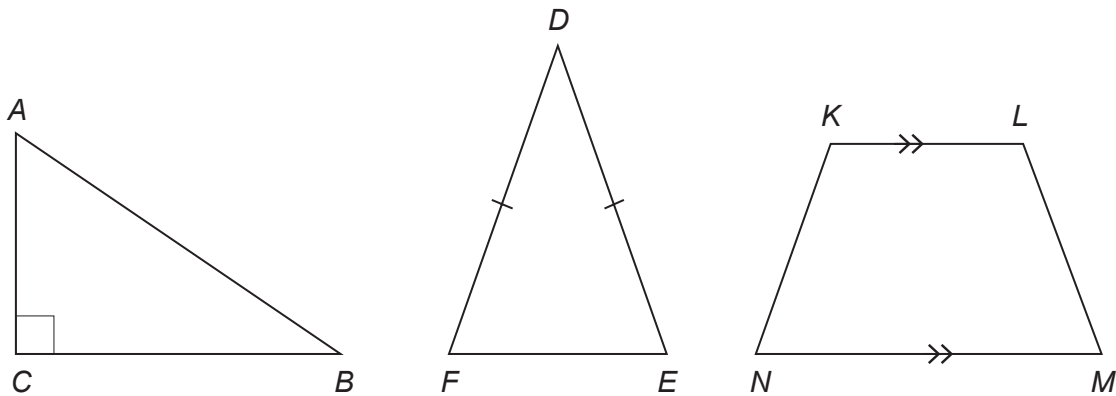

Circle the correct answer for each of the following statements.

[3]

(i) The right angle is

$\hat{A}BC$

$\hat{B}AC$

$\hat{A}CB$

$\hat{D}FE$

$\hat{D}EF$

(ii) A line parallel to KL is

KN

NM

AB

LM

AC

(iii) Triangle DEF is

scalene

equilateral

right-angled

isosceles

4. The following fair five-sided spinner is spun once in a game.

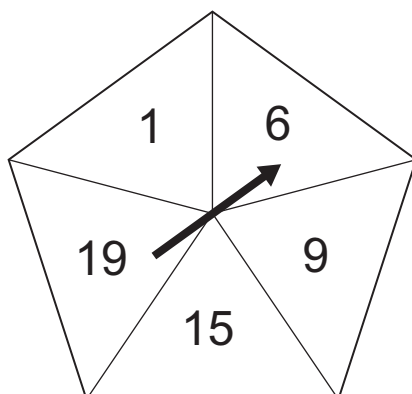

Examiner
only

What is the probability that the pointer will land on

- (a) an odd number,

[1]

.....

.....

.....

- (b) a square number?

[1]

.....

.....

.....

5. Solve the following equations.

(a) $x + 3 = 12$

[1]

.....

.....

.....

(b) $\frac{y}{2} = 10$

[1]

.....

.....

.....

(c) $8z + 13 = 27$

[2]

.....

.....

.....

6. The diagram shows a company logo.
It is made by removing a square from a rectangle and replacing it as shown.

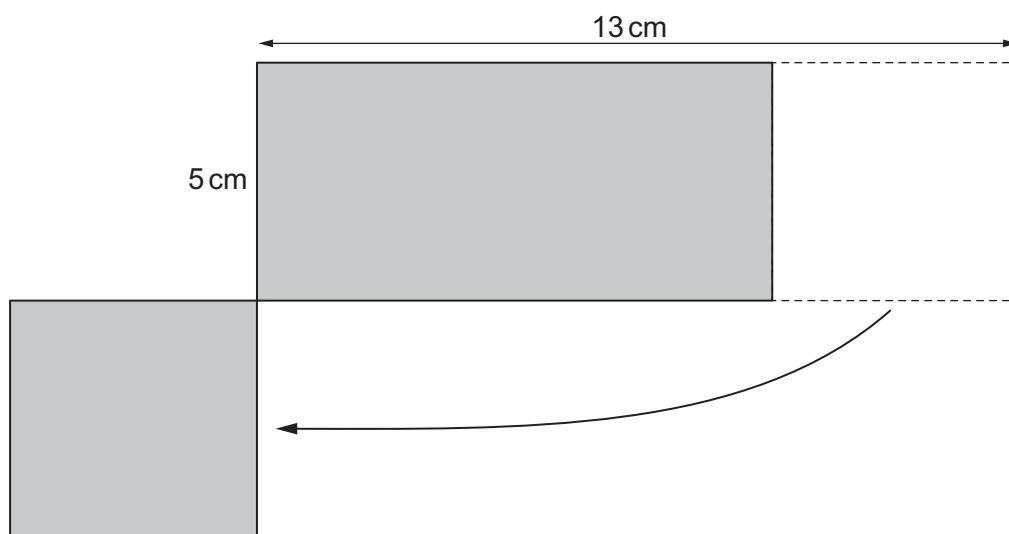

Diagram not drawn to scale

Is the perimeter of the logo greater, smaller or the same as the perimeter of the original rectangle?
Circle your answer.

Greater

Smaller

The same

Give a reason for your answer.

[2]

.....

.....

.....

.....

7. (a) Simplify $p + p + p$.

[1]

.....

(b) Simplify $3a + 4b + 5a - 2b$.

[2]

.....

.....

(c) Simplify $2 \times 3c$.

[1]

.....

(d) Expand $3(a + 6)$.

[1]

.....

8. Write the following numbers in ascending order.

0.65 $\frac{2}{3}$ 60% 0.615

You must show all your working.

[2]

.....

.....

.....

.....

.....



BLANK PAGE

9. Jack has been set this problem by his teacher.
'How many cubes with sides of length 2 cm will fit inside the box?'

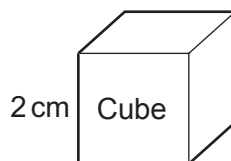

Diagram not drawn to scale

The box is a cuboid with the measurements shown.

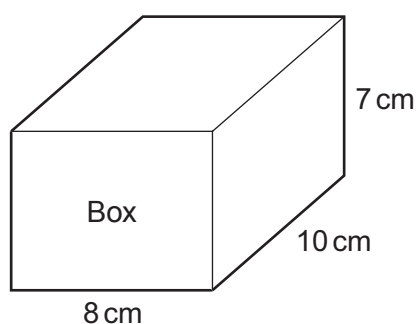

Diagram not drawn to scale

Jack has worked out that:

- The volume of the cube is 8 cm^3 .
- The volume of the box is 560 cm^3 .
- $560 \div 8 = 70$
- So 70 cubes will fit inside the box.

Jack's teacher has checked his work and told him that all his calculations are correct but his answer to the problem is wrong.

- (a) What is wrong with the method Jack used?

[1]

.....

.....

.....

.....

(b) What effect has Jack's method had on his answer to the problem?

[1]

Examiner
only

.....

.....

(c) Calculate how many cubes will fit inside the box.

[2]

.....

.....

.....

Examiner only

10. In a competition, there were two teams, *Axis* and *Beta*.
The teams bought and sold children's toys.
The winning team was the one that gained the most profit.

Team Axis

Final Profit
£10

Team Beta

Bought 160 toys for £4.60 each
Sold 75% of the toys for £5.20 each
Sold the remaining toys for £3 each

Which team won the competition?
How much more profit did the winning team make?

[6]

.....

.....

.....

.....

.....

.....

.....

.....

.....

.....

.....

.....

.....

.....

.....

.....

.....

.....

.....

.....

.....

.....

.....

11. Sharifa keeps a record of the number of phone calls she makes each day. These are her results for one week.

7 9 6 3 7 9 6

(a) Why is the mode not suitable to use as the average number of calls made each day? [1]

.....
.....
.....

(b) Work out the range, and the median number of calls made each day. [2]

.....
.....
.....

Range Median

(c) When Sharifa does not include the calls made on Saturday and Sunday, the new range is 4.

(i) How many calls were made on Saturday? [1]

.....
.....

(ii) What impact does this have on the median? [1]

.....
.....

Examiner
only

12. Next Wednesday, Omar plans to spend $\frac{1}{12}$ of the day playing tennis, $\frac{3}{8}$ working, and 8 hours sleeping.

Show that Omar will have enough time to go on a shopping trip that lasts 2 hours. [3]

.....

.....

.....

.....

.....

.....

.....

.....

.....

13. Two companies, *Sail-Away* and *Cross-Quick*, have ferries that sail between Dover and Calais.

- *Sail-Away* ferries depart every 20 minutes.
- *Cross-Quick* ferries depart every 25 minutes.

Both companies have ferries that leave Dover at 9:00 a.m.
What is the next time that the two companies have ferries leaving Dover at the same time? [3]

.....

.....

.....

.....

.....

.....

.....

.....

.....

14. Daniel has a piece of rope.

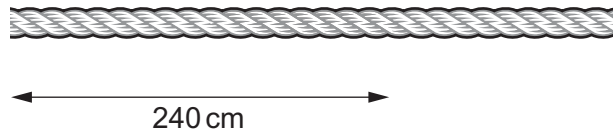

$\frac{5}{8}$ of the total length of the rope is 240 cm.

Calculate the total length of the rope.

[3]

.....

.....

.....

.....

15. A pack of 500 sheets of paper is called a ream.

A ream of paper has a height of 5.3 cm.

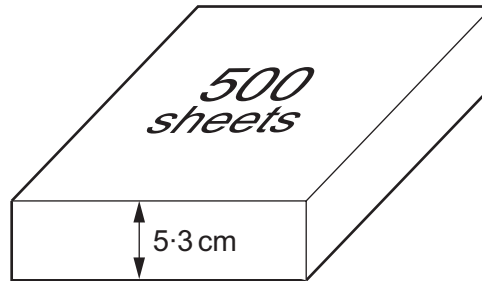

Diagram not drawn to scale

- (a) Jazmin would like to stack as many reams as possible in a space that is 1.25 metres high.

How many complete reams of paper could she stack in this space? [3]

.....

.....

.....

.....

.....

.....

.....

.....

- (b) Harry needs 6530 sheets of paper.
He calculates how many reams of paper he needs as follows:

Calculation: $6530 \div 500 = 13.06$
Conclusion: I need 13 reams of paper.

Is Harry's conclusion correct?
You must justify your decision. [1]

.....

.....

.....

Examiner only

16. Boris has made this pattern out of black and white squares.



Boris has to add more squares to make a new pattern.
He has to use the smallest possible number of extra squares.

$\frac{2}{5}$ of the new pattern is black.

How many black squares and white squares will there be in the new pattern? [2]

.....

.....

.....

.....

.....

Black squares White squares

17. Robert and Sheila have been given £400, which they plan to share in the ratio 1 : 4.

(a) Robert says



Explain what is wrong with Robert's method. [1]

.....

.....

(b) Calculate the amounts that each of them should get. [2]

.....

.....

Robert's share = £..... Sheila's share = £.....

Examiner only

18. (a) In Sumston, the current population is 320% of the population it was in 1983.

Naomi says

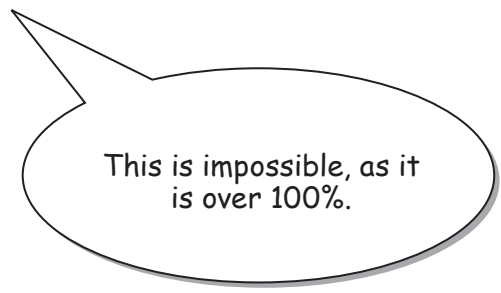

Explain how a value of 320% is possible. [1]

.....

.....

(b) In 1967, the population of Timesville was 40 000.
 In January 2017, the population of Timesville was 250 000.

Write the January 2017 population as a percentage of the 1967 population. [2]

.....

.....

.....

19. Jane has just taken two mathematics tests.

Her results were:

- 35 out of 40 in test 1,
- 31 out of 35 in test 2.

In which of these tests did Jane have the better result? You must show all your working. [4]

.....

.....

.....

.....

.....

Jane had a better result in test

20. (a) The n th term of a sequence is $3n - 2$.
Write down the first **three** terms in the sequence. [2]

.....

.....

.....

- (b) Reza says

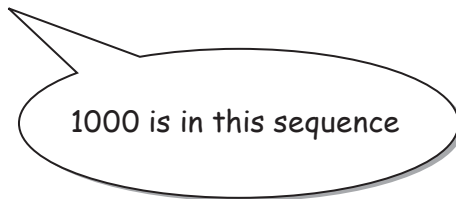

Show that Reza is correct. [2]

.....

.....

.....

21. Luca has to use the formula

$$v = u + at.$$

- (a) Find the value of v when $u = 53$, $a = -4$, and $t = 6$. [2]

.....

.....

.....

- (b) Find the value of u when $v = 20$, $a = 2$ and $t = 6$. [2]

.....

.....

.....

- (c) Rearrange the formula to make t the subject. [2]

.....

.....

.....

22. *Wellbuilt Caravans* decided to reduce the mass of their caravans to make them easier to tow behind modern lightweight cars.

In 2015, they reduced the mass of their caravans by 8%.

In 2016, they reduced the mass of their caravans by a further 3%.

The original mass of a *WB1* caravan was 1000 kg.

- (a) What is the mass of a new *WB1* caravan after both the reductions? [3]

.....

.....

.....

.....

.....

- (b) What percentage of the original mass was the caravan reduced by? [2]

.....

.....

.....

23. (a) Draw the graph of $y = 2x + 5$ for values of x from -2 to $+3$.
Use the graph paper below.

Examiner
only

[3]

.....

.....

.....

.....

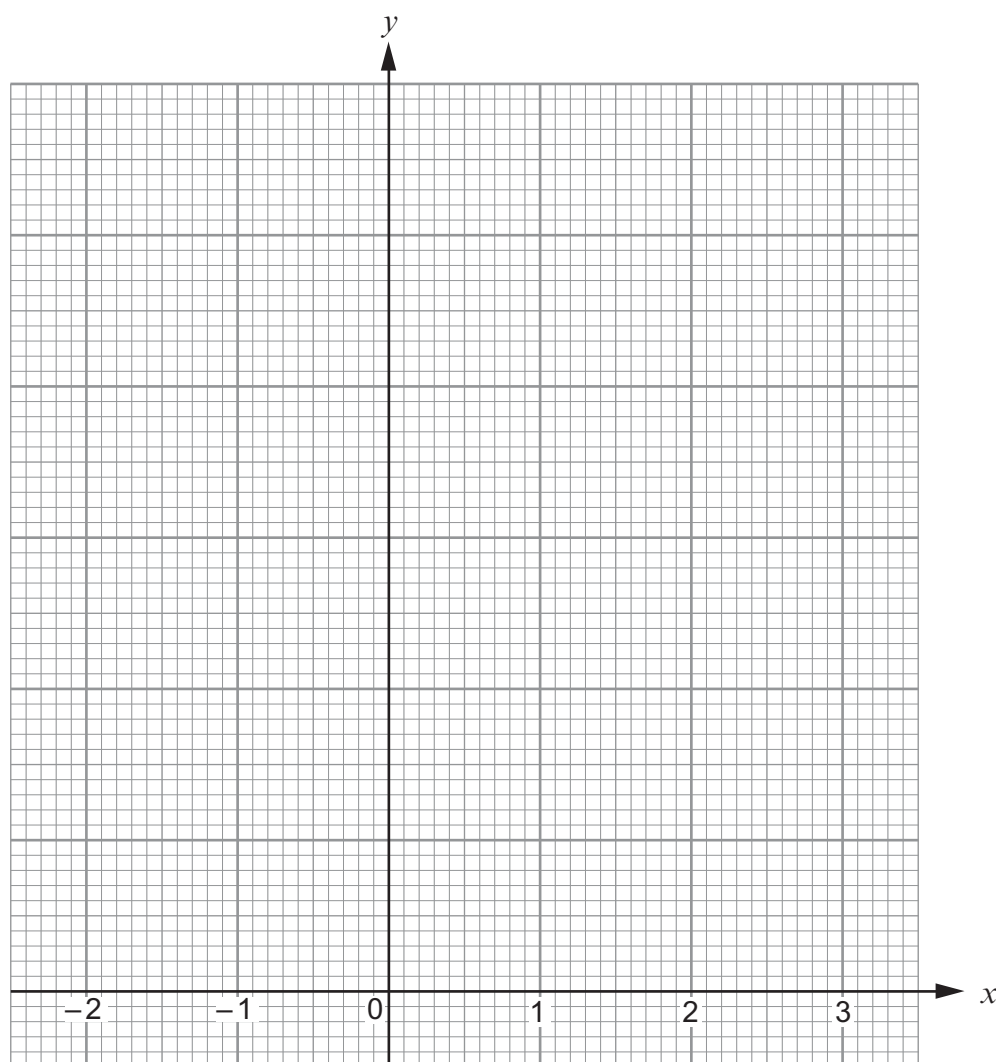

- (b) Are the lines $y = 3x - 5$ and $y = 3x + 1$ parallel?
You must give a reason for your answer.

[1]

.....

.....

24.

Examiner only

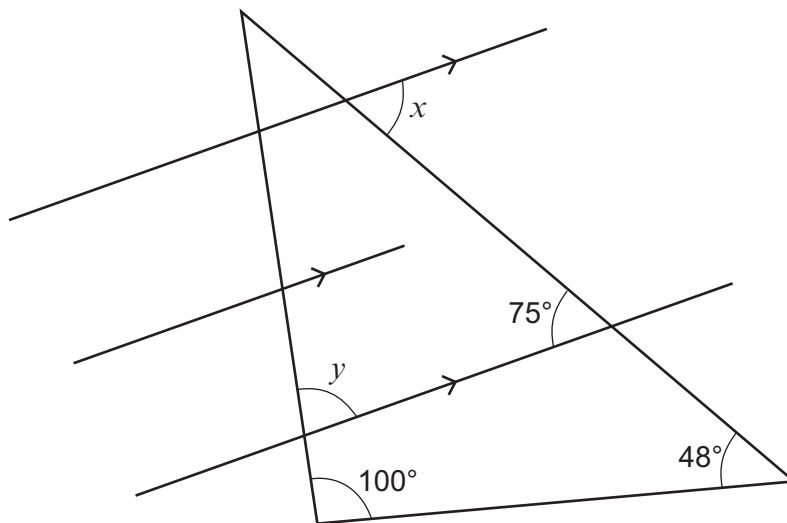

Diagram not drawn to scale

Work out the sizes of angle x and angle y .

[3]

.....

.....

.....

.....

.....

.....

.....

.....

.....

.....

.....

.....

.....

.....

.....

.....

.....

$x = \dots\dots\dots^\circ$

$y = \dots\dots\dots^\circ$

Examiner
only

25. The area of a circle is 24 cm^2 .

Calculate the radius of the circle.

[3]

.....

.....

.....

.....

.....

.....

.....

.....

.....

.....

.....

.....

.....

.....

.....

.....

.....

.....

.....

.....

.....

.....

Radius is cm

26. Work out the answer.
Give your answer in standard form.

$$4.5 \times 10^{-6} \times 3.4 \times 10^{20}$$

[1]

.....

.....

.....

.....

.....

27. (a)

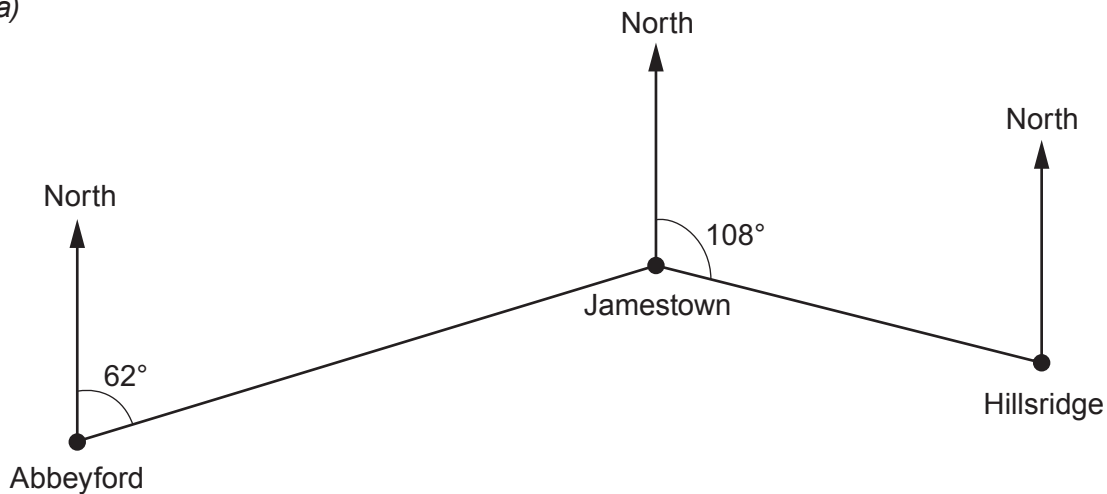

Diagram not drawn to scale

(i) What is the bearing of Jamestown from Abbeyford? [1]

.....

.....

(ii) What is the bearing of Jamestown from Hillsridge? [1]

.....

.....

.....

(b) The actual distance between Abbeyford and Jamestown is 20 km.
On the map the distance between Abbeyford and Jamestown is 8 cm.
Work out the scale of the map.

Give your answer in the form 1 : [2]

.....

.....

.....

.....

.....

.....

Scale of map 1 :

Examiner
only

28. It takes 3 people 6 days to mow a grass verge.

(a) How many days would it take 9 people to mow a grass verge that is **twice as long**? [2]

.....

.....

.....

.....

.....

.....

.....

.....

.....

..... days

(b) State **one** assumption you have made in answering this question. [1]

.....

.....

.....

.....

.....

29. A festival was held over 10 days.
An ice cream van was parked on the festival site each day.

The scatter diagram shows the number of people attending the festival on each of the days and the amount of money taken by the ice cream van.

Amount of money taken (£)

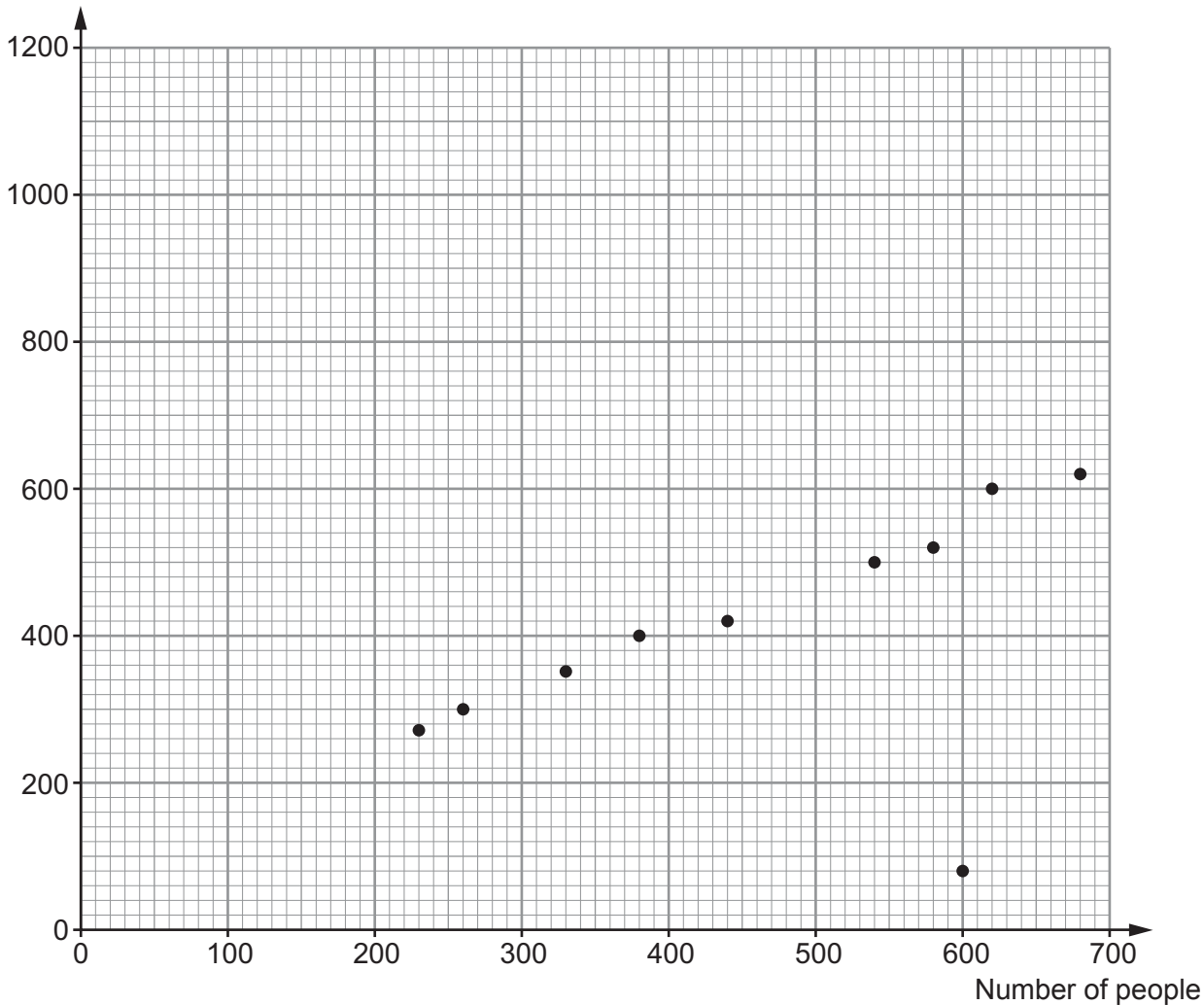

- (a) It was really cold and wet on one of the days.
Although lots of people attended on this day, the amount of money taken by the ice cream van was very low.

On this cold and wet day:

- how many people attended the festival?
- what was the amount of money taken by the ice cream van?

[1]

Number of people

Amount of money taken £

Examiner
only

(b) Ignoring the outlier, draw a line of best fit on the scatter diagram. [1]

(c) (i) Estimate the amount of money that the ice cream van may have taken at the festival had only 50 people attended on a particular day. [1]

Estimate is £

(ii) Why is this estimate unlikely to be accurate? [1]

.....
.....
.....
.....
.....
.....

(d) Estimate how much each person attending the festival spends at the ice cream van. You must give the unit of your answer. [1]

.....
.....

Estimate is per person

30. Expand and simplify $(2x + 3)(x - 5)$. [2]

.....
.....
.....
.....
.....
.....
.....

Examiner
only

31. Huw and Catrin are playing a game where Huw rolls an ordinary six-sided dice and Catrin spins a fair five-sided spinner, numbered 1, 2, 3, 4 and 5 as shown.

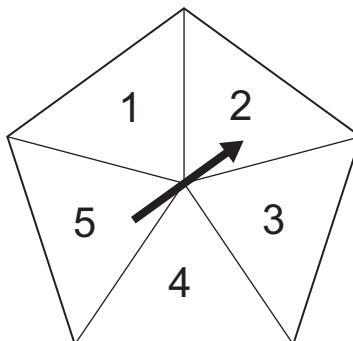
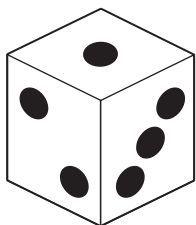

Show that the probability that they both show the same number is $\frac{1}{6}$.

[3]

.....

.....

.....

.....

.....

.....

.....

.....

.....

.....

.....

Examiner
only

32. Rosa starts a 27 km cycle race at 14:20.
She finishes the cycle race at 16:00.
Rosa set herself a target of achieving an average speed of 20 km per hour for the race.

(a) Did Rosa achieve her target?
You must show all your working.

[3]

.....

.....

.....

.....

.....

.....

.....

.....

.....

.....

(b) During the cycle race Rosa stopped for 25 minutes to mend a puncture.
Had she not needed to stop to mend her puncture, how would this have impacted on her

- average speed and
- achieving her target?

You must show all your working.

[2]

.....

.....

.....

.....

.....

.....

.....

.....

33. The table shows rainfall, for each day during a month.

Rainfall, r (mm)	Number of days
$0 \leq r < 4$	2
$4 \leq r < 8$	7
$8 \leq r < 12$	10
$12 \leq r < 16$	8
$16 \leq r < 20$	3

Calculate an estimate for the mean daily rainfall.

[4]

.....

.....

.....

.....

.....

.....

.....

END OF PAPER

BLANK PAGE

